

## **MP-1919**

### **XNOVA Cube™ SMD LED**



#### **Table of Contents**

Technology Overview . . . . .2

Product Selection Table . . . . .3

Operating Characteristics . .4

Chromaticity Binning. . . . .5

Chromaticity Diagram. . . . .6

Characteristic Graphs . .7 & 8

Ordering Information . . . . .9

Product Dimensions. . . . . 10

Solder Pad Pattern . . . . . 10

Dimensions of Tape . . . . . 11

Reel Dimensions . . . . . 12

Reel Packaging. . . . . 12

Box Packaging . . . . . 13

#### **Features:**

---

- Wide viewing angle: 170 degrees
- Hot lumen color targeted
- 1.63W maximum operating input power
- Compact: 1.9mm x 1.9mm
- High efficacy: up to 143 lumens per watt
- Wide color selection: 2700K-5000K
- 6V input
- Compatible with automatic placement equipment
- Compatible with infrared reflow solder process
- RoHs and REACH compliant

#### **Applications**

---

- Replacement lamps
- Panel lighting
- Down lights
- Cove lighting
- Architectural lighting
- Channel lighting

## Technology Overview

Luminus XNOVA Cube™ LEDs are lighting class solutions designed for high performance general lighting applications. These state-of-the-art LEDs allow illumination engineers and designers to develop lighting solutions with maximum efficacy, brightness and overall quality. The XNOVA Cube™ is a unique LED that provides the benefits of a wide emission angle within a compact footprint. The 1.9mm x 1.9mm package emits into a 170 degree viewing angle, enabling designers with new degrees of freedom to solve many of today's most challenging lighting problems. The very wide viewing angle promotes Energy Star compliance for replacement lamps, and results in increased mixing and uniformity for linear and area lighting. The miniature package size with high lumen density creates a "point source" of light that provides flexibility to develop innovative optical solutions. Additionally, the XNOVA Cube advances the hallmark characteristics of the XNOVA family, including high efficacy and color fidelity. XNOVA LEDs – the right choice for color quality, efficacy and reliability.

### Reliability

The XNOVA Cube is one of the most reliable light sources in the world today. Having passed a rigorous suite of environmental and mechanical stress tests, including mechanical shock, vibration, temperature cycling and humidity, it is fully qualified for use in a wide range of high performance and high efficacy lighting applications.

### REACH & RoHS Compliance

The XNOVA Cube LED is compliant to the Restriction of Hazardous Substances Directive or RoHS. The restricted materials including lead, mercury cadmium hexavalent chromium, polybrominated biphenyls (PBB) and polybrominated diphenyl ether (PBDE) are not used.

## Understanding XNova™ LED Test Specifications

Every XNOVA LED is fully tested to ensure it meets the high quality standards customers have come to expect from Luminus products.

### Testing Temperature

XNOVA Cube MP-1919 LEDs are tested at 25°C and binned so that the resultant chromaticity is along the blackbody locus at typical operating conditions.

**Product Selection Table**

Test condition = 150 mA, 25C

Nominal CCT	Minimum CRI	Ordering Part Number	Minimum Flux (Lumens)	Typical Flux (Lumens)
2700K	80	MP-1919-2100-27-80	94	101
	90	MP-1919-2100-27-90	75	79
3000K	80	MP-1919-2100-30-80	100	107
	90	MP-1919-2100-30-90	81	91
3500K	80	MP-1919-2100-35-80	100	111
	90	MP-1919-2100-35-90	87	95
4000K	80	MP-1919-2100-40-80	107	115
	90	MP-1919-2100-40-90	87	100
5000K	80	MP-1919-2100-50-80	107	117
	90	MP-1919-2100-50-90	87	100

Nominal CCT	Minimum CRI	Ordering Part Number	Minimum Flux (Lumens)	Typical Flux (Lumens)
2700K	80	MP-1919-2101-27-80	100	108
	90	MP-1919-2101-27-90	81	84
3000K	80	MP-1919-2101-30-80	107	114
	90	MP-1919-2101-30-90	87	97
3500K	80	MP-1919-2101-35-80	107	118
	90	MP-1919-2101-35-90	94	102
4000K	80	MP-1919-2101-40-80	114	122
	90	MP-1919-2101-40-90	94	105
5000K	80	MP-1919-2101-50-80	114	124
	90	MP-1919-2101-50-90	94	105

**1919 Mid Power Operating Characteristics**

**Optical and Electrical Characteristics(Ta=25°C)**

Parameter	Symbol	Minimum	Typical	Maximum	Unit	Condition
Forward Voltage	V <sub>F</sub>		6.2	6.9	V	I <sub>F</sub> =150mA
Reverse Current	I <sub>R</sub>			10	uA	V <sub>R</sub> =5V
Viewing Angle	2θ <sub>1/2</sub>		170		°	I <sub>F</sub> =150mA
Thermal Resistance	R <sub>th(j-sp)</sub>		8		°C/W	I <sub>F</sub> =150mA
Electrostatic Discharge	ESD	1000			V	

Note 1: To prevent damage refer to operating conditions and derating curves for appropriate maximum operating conditions

Note 2: Maximum operating case temperature combined with maximum drive current defines the total maximum operating condition for the device. To prevent damage, please follow derating curves for all operating conditions.

Note 3: XNOVA Cube are designed for operation up to an absolute maximum forward drive current as specified below. Product lifetime data is specified at typical forward drive currents. Sustained operation at absolute maximum currents will result in a reduction of device lifetime compared to typical forward drive currents. Actual device lifetimes will also depend on case temperature. Refer to the current vs. case temperature derating curves for further information.

Note 4: Caution must be taken not to stare at the light emitted from these LEDs. Under special circumstances, the high intensity could damage the eye.

**Absolute Maximum Ratings (Ta=25°C)**

Parameter	Symbol	Rating	Unit
Forward Current	I <sub>F</sub>	240	mA
Pulse Forward Current	I <sub>FP</sub>	300	mA
Power Dissipation	P <sub>D</sub>	1,632	mW
Reverse Voltage	V <sub>R</sub>	5	V
Operating Temperature	T <sub>OPR</sub>	-40~+80	°C
Storage Temperature	T <sub>STG</sub>	-40~+80	°C
Junction Temperature	T <sub>J</sub>	115	°C
Soldering Temperature	T <sub>SLD</sub>	230 °C or 260 °C for 10 sec	

\*I<sub>FP</sub> condition with Pulse: Width ≤100μs Duty cycle ≤1/10

## Chromaticity Binning

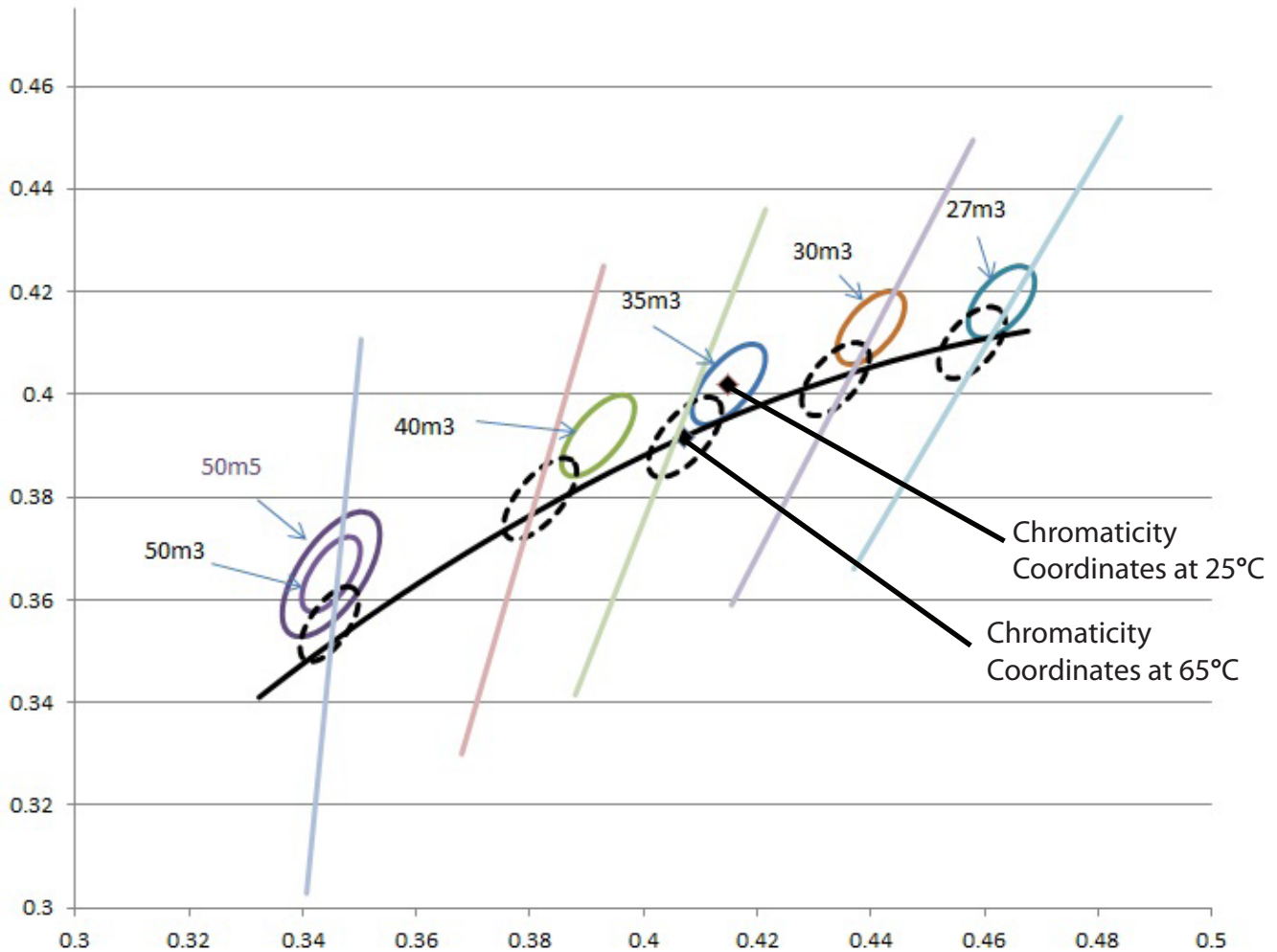

### Chromaticity Binning

The chart above shows the typical chromaticity shift from 25°C to 65°C. XNOVA Cube MP-1919 LEDs are tested at 25°C and binned so that the resultant chromaticity is along the blackbody locus at typical operating conditions.

\*Notes: m3 denotes a 3-step MacAdam ellipse, m5 denotes a 5-Step MacAdam ellipse.

Luminus maintains a +/- 0.01 tolerance on chromaticity (CIEx and CIEy) measurements.

## Chromaticity Diagram

### Color Bin Structure

Color Code	Center		Radius		Angle(deg)
	x	y	a	b	$\phi$
27m3	0.4582	0.4099	0.008100	0.00420	53.42
30m3	0.4342	0.4028	0.008340	0.00408	53.13
35m3	0.4073	0.3917	0.009270	0.00414	53.22
40m3	0.3825	0.3789	0.009390	0.00402	53.43
50m3	0.3451	0.3554	0.008220	0.00354	59.37
50m5	0.3451	0.3554	0.013700	0.00590	59.37

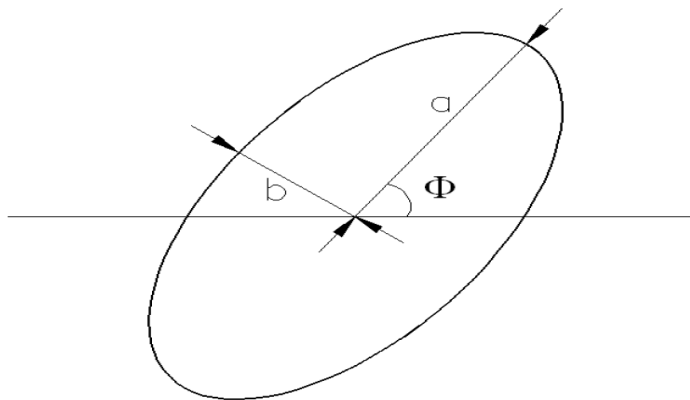

Notes: Chromaticity coordinate definition represents the projected performance at operating condition of 65°C.  
Tolerance of measurements of the chromaticity Coordinate is  $\pm 0.005$   
Chromaticity coordinates as per ANSI standard.

#### Typical Optical/Electrical Characteristics Graphs

**Vf-----IF**

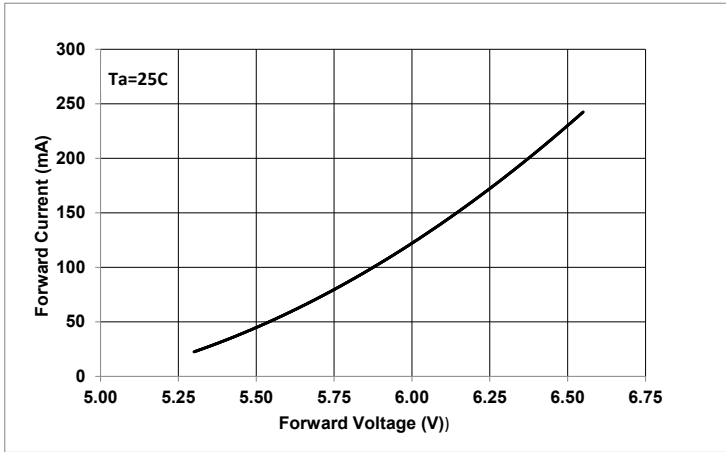

**IF---- Relative Luminous flux**

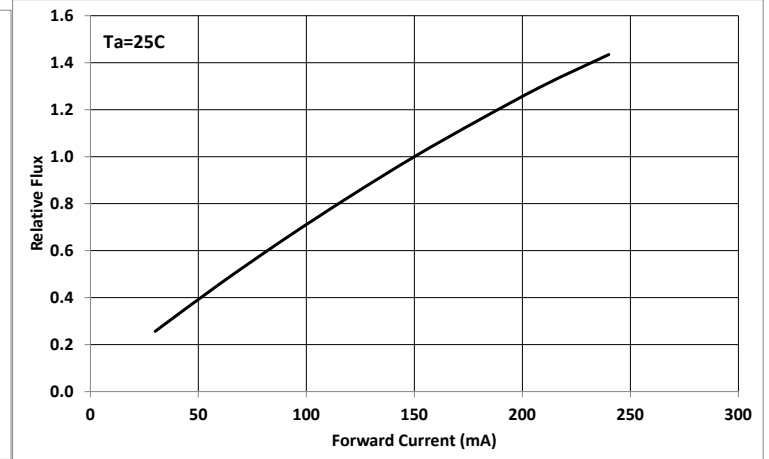

**Tj-----Relative Luminous Flux**

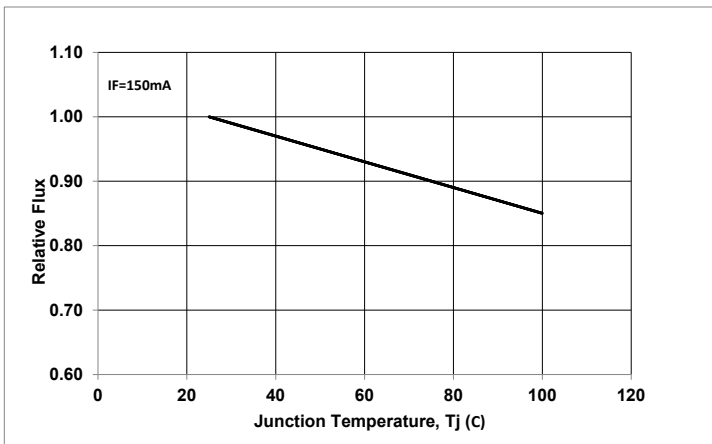

**Wavelength- Relative Emission Intensity**

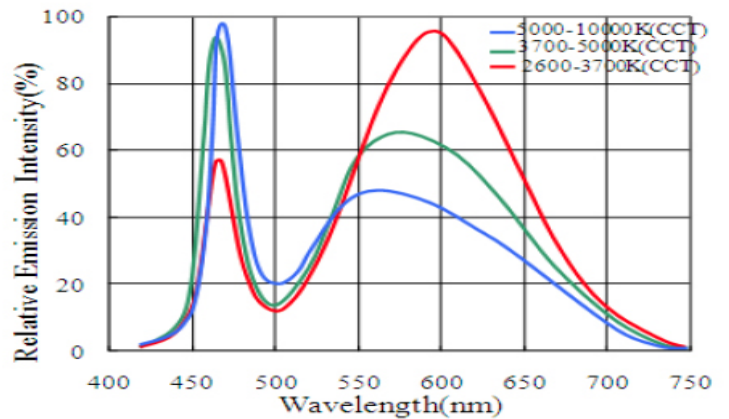

\*Note: Luminus maintains a +/- 0.01 tolerance on chromaticity (CIEx and CIEy) measurements.

### Typical Optical/Electrical Characteristics Graphs

#### Typical Polar Radiation Pattern

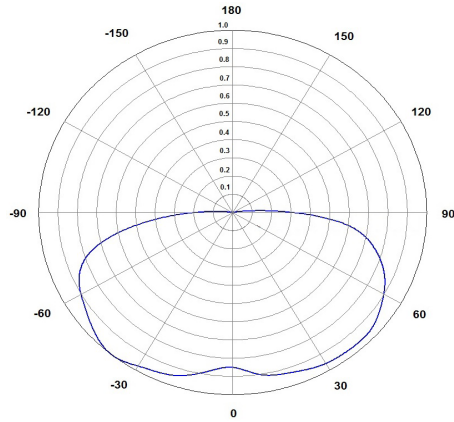

#### Tj -- Forward Voltage

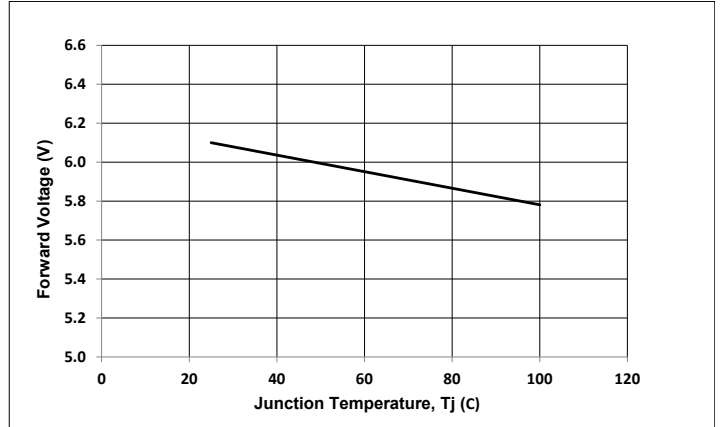

#### Chromaticity vs Temperature

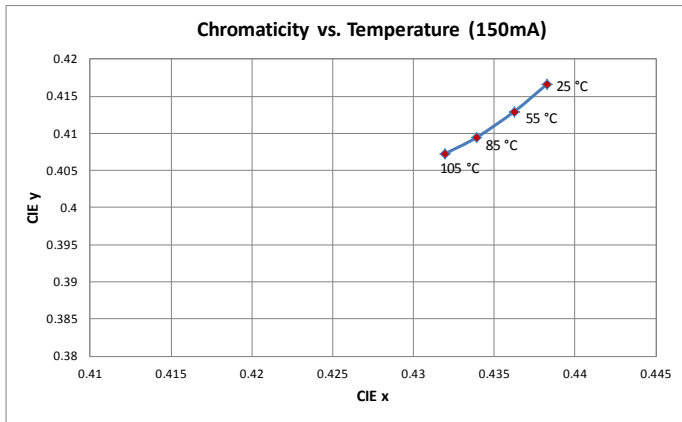

#### Chromaticity vs Current

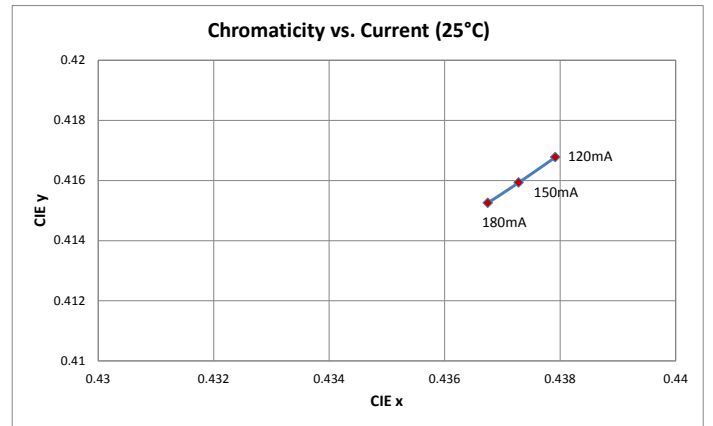

#### Current vs Tj

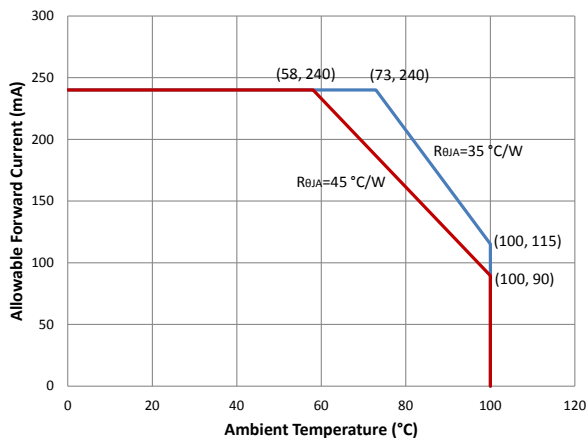



**Product Ordering and Shipping Part Number Nomenclature**

All XNOVA Cube products are packaged and labeled with part numbers as outlined in below. When shipped, each reel will contain only a single flux and voltage bin. The part number designation is as follows:

**1919 XNOVA Cube LEDs**

XNOVA Cube	Package Type	Package Configurator	Nominal CCT	Minimum CRI
MP	1919	2100	##	##

Example:

The part number MP-1919-2100-30-80 refers to a XNOVA Cube emitter with nominal color temperature of 3,000k, minimum CRI of 80 within a 3-step ellipse.

Please refer to page 3 for a description of available CCT and CRI combinations.

Notes: CCT Codes:

- 27 = 2700 k
- 30 = 3000 k
- 35 = 3500k
- 40 = 4000 k
- 50 = 5000 k

CRI Codes:

- 80
- 90

Each mid power product shipped will be labeled with its specific flux and voltage bins. Not all bins listed are available in all CCTs and CRIs.

**Luminus Flux Bins (Ta= 25°C)**

Bin Code	Minimum Flux (Lumens)	Maximum Flux (Lumens)
1X	75	81
1Y	81	87
1Z	87	94
2A	94	100
2B	100	107
2C	107	114
2D	114	122
2E	122	130
2F	130	139
2G	139	148
2H	148	158

**Forward Voltage Bins (Ta=25°C)**

Bin Code	Minimum Voltage (Volts)	Maximum Voltage ( Volts)
B	5.9	6.1
C	6.1	6.3
D	6.3	6.5
E	6.5	6.7
F	6.7	6.9

\*Tolerance of measurements f the Forward Voltage is ±0.1V

## Product Dimensions (mm)

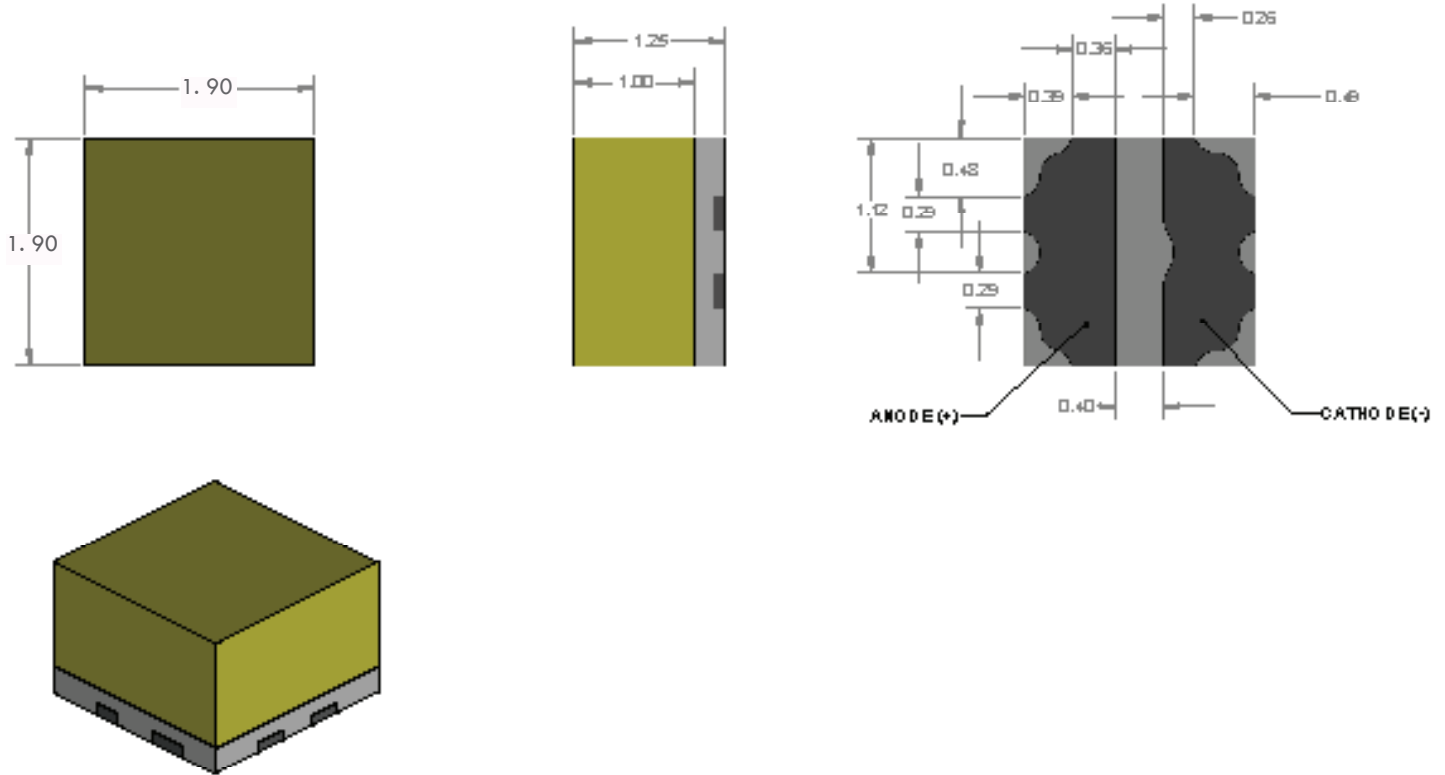

## Recommended Soldering Pad Pattern

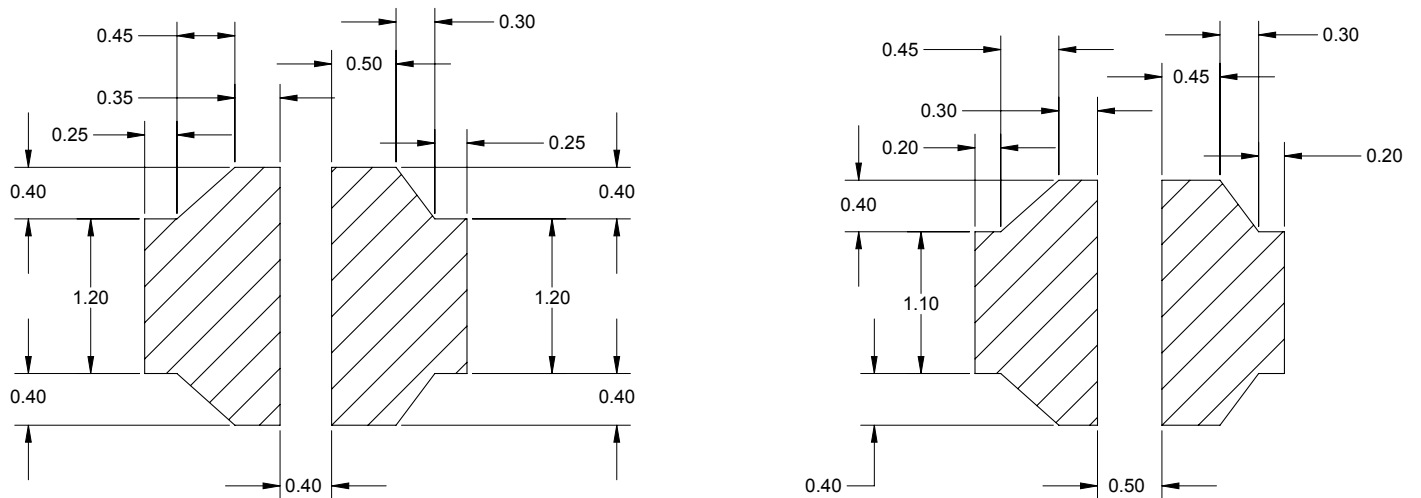

**RECOMMENDED SOLDER PAD**

**RECOMMENDED STENCIL PATTERN**

**Dimensions of tape (mm)**

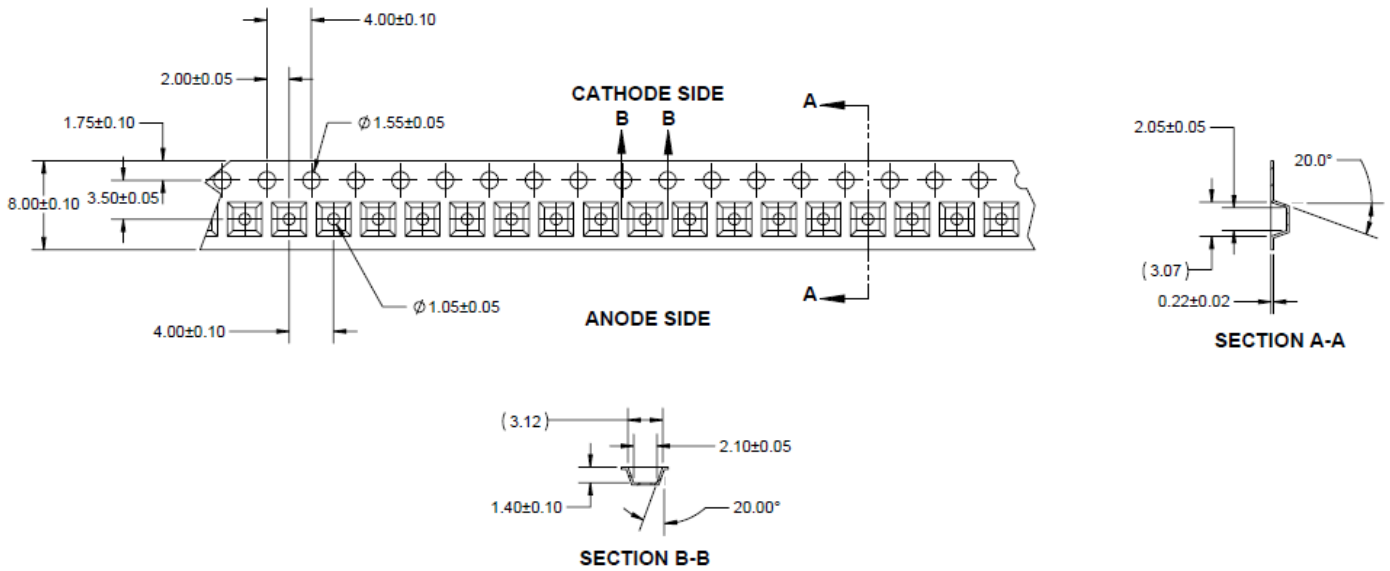

## Reel Dimensions (mm)

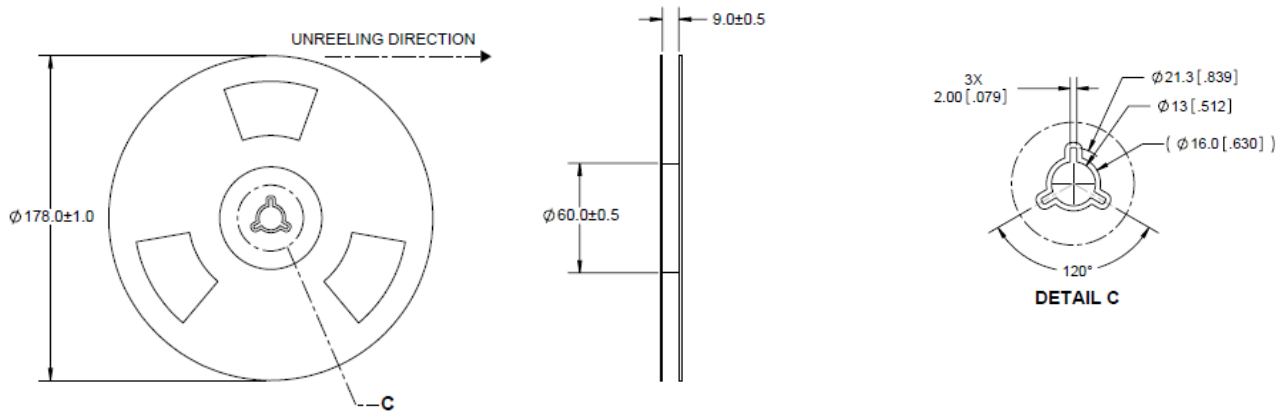

## Reel Packaging

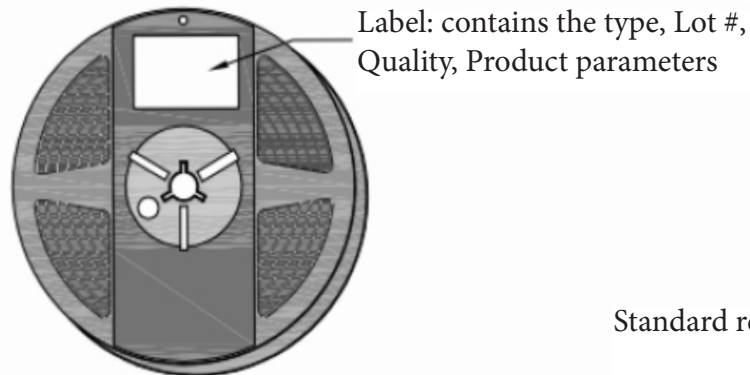

Standard reel quantity: 3000 pcs

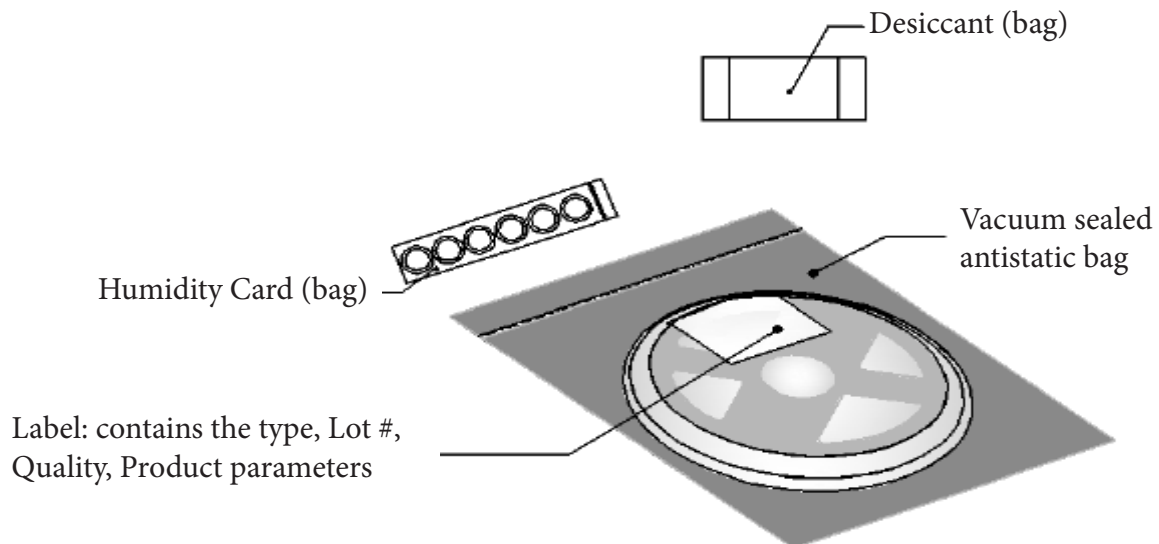

### Box Packaging Information



\*Capacity 5 reels per box



Label: contains the type,  
Lot #, Quality, Product  
parameters



\*Capacity 10 reels per box



Label: contains the type,  
Lot #, Quality, Product  
parameters

### Precaution for Use

#### Storage:

1. Recommended storage condition:  
At 5 °C - 30 °C and relative humidity 60% RH max.
2. After this bag is opened, devices that will be applied to infrared reflow, vapor- phase reflow, or equivalent soldering process must be :
  - a) Completed within 24 hours.
  - b) Stored at less than 30% RH.
3. Devices require baking before mounting, if :  
2a or 2b is not met.
- 4) If baking is required, devices must be baked under below conditions:  
24 hours at 60 °C ± 5 °C.

#### Static Electricity:

1. The products are sensitive to static electricity, and care should be taken when handling them.
2. Static electricity or surge voltage will damage the LEDs. It is recommended to wear a anti-electrostatic wristband or an anti-electrostatic gloves when handling the LEDs.
3. All devices, equipment and machinery must be properly grounded. It is recommended that measures be taken against surge voltage to the equipment that mounts the LEDs.